



## 4 x 45W QUAD BRIDGE CAR RADIO AMPLIFIER PLUS HSD

PRODUCT PREVIEW

- SUPERIOR OUTPUT POWER CAPABILITY:
  - 4 x 50W/4Ω MAX.
  - 4 x 45W/4Ω EIAJ
  - 4 x 30W/4Ω @ 14.4V, 1KHz, 10%
  - 4 x 80W/2Ω MAX.
  - 4 x 77W/2Ω EIAJ
  - 4 x 55W/2Ω @ 14.4V, 1KHz, 10%
- EXCELLENT 2Ω DRIVING CAPABILITY
- HI-FI CLASS DISTORTION
- LOW OUTPUT NOISE
- ST-BY FUNCTION
- MUTE FUNCTION
- AUTOMUTE AT MIN. SUPPLY VOLTAGE DETECTION
- LOW EXTERNAL COMPONENT COUNT:
  - INTERNALLY FIXED GAIN (26dB)
  - NO EXTERNAL COMPENSATION
  - NO BOOTSTRAP CAPACITORS
- ON BOARD 0.35A HIGH SIDE DRIVER

### PROTECTIONS:

- OUTPUT SHORT CIRCUIT TO GND, TO  $V_s$ , ACROSS THE LOAD
- VERY INDUCTIVE LOADS
- OVERRATING CHIP TEMPERATURE WITH SOFT THERMAL LIMITER
- LOAD DUMP VOLTAGE

### BLOCK AND APPLICATION DIAGRAM

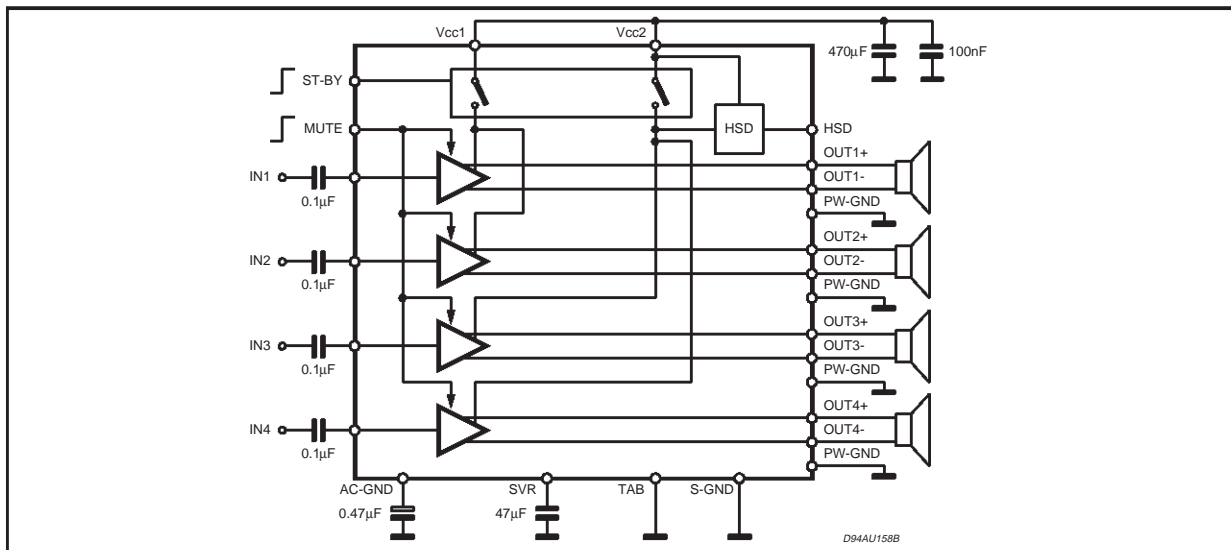

MULTIPOWER BCD TECHNOLOGY

MOSFET OUTPUT POWER STAGE

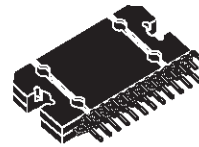

FLEXIWATT25

ORDERING NUMBER: TDA7560

- FORTUITOUS OPEN GND
- REVERSED BATTERY
- ESD

### DESCRIPTION

The TDA7560 is a breakthrough BCD (Bipolar / CMOS / DMOS) technology class AB Audio Power Amplifier in Flexiwatt 25 package designed for high power car radio

The fully complementary P-Channel/N-Channel output structure allows a rail to rail output voltage swing which, combined with high output current and minimised saturation losses sets new power references in the car-radio field, with unparalleled distortion performances.

# TDA7560

## ABSOLUTE MAXIMUM RATINGS

Symbol	Parameter	Value	Unit
$V_{CC}$	Operating Supply Voltage	18	V
$V_{CC(DC)}$	DC Supply Voltage	28	V
$V_{CC(pk)}$	Peak Supply Voltage (t = 50ms)	50	V
$I_o$	Output Peak Current: Repetitive (Duty Cycle 10% at f = 10Hz) Non Repetitive (t = 100 $\mu$ s)	9 10	A A
$P_{tot}$	Power dissipation, (T <sub>case</sub> = 70°C)	80	W
$T_j$	Junction Temperature	150	°C
$T_{stg}$	Storage Temperature	- 55 to 150	°C

## PIN CONNECTION (Top view)

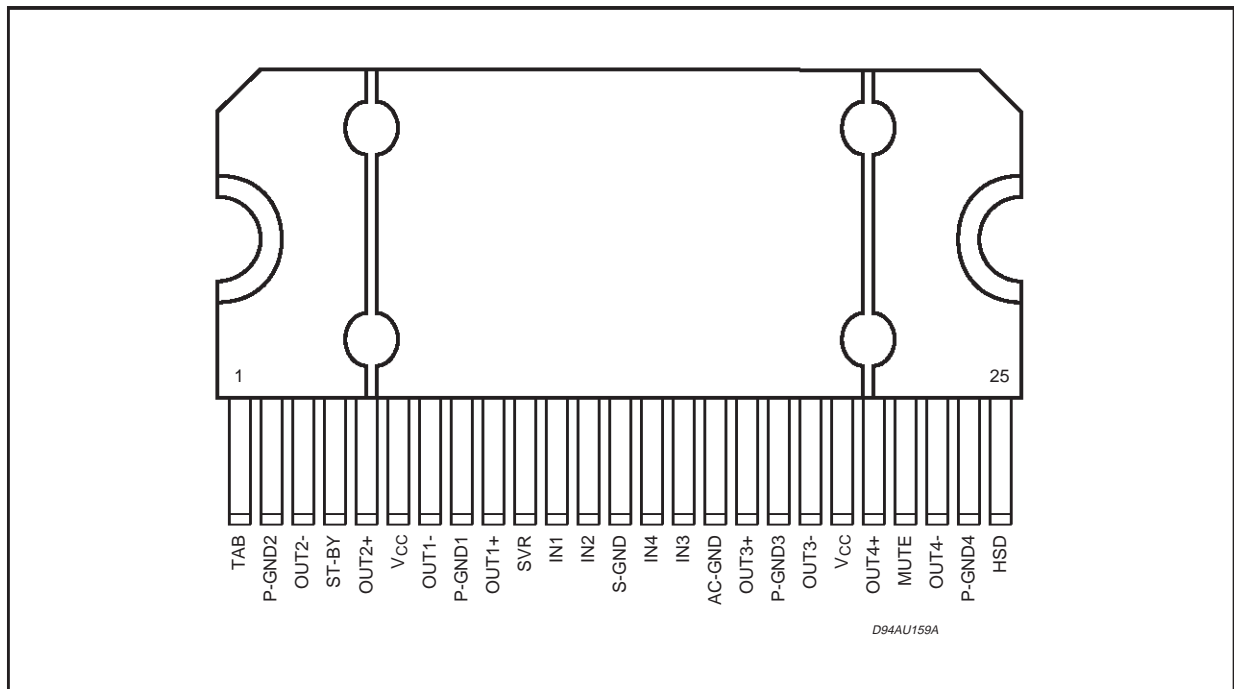

## THERMAL DATA

Symbol	Parameter	Value	Unit
$R_{th j-case}$	Thermal Resistance Junction to Case	Max. 1	°C/W

**ELECTRICAL CHARACTERISTICS** ( $V_S = 13.2V$ ;  $f = 1KHz$ ;  $R_g = 600\Omega$ ;  $R_L = 4\Omega$ ;  $T_{amb} = 25^\circ C$ ;  
Refer to the test and application diagram, unless otherwise specified.)

Symbol	Parameter	Test Condition	Min.	Typ.	Max.	Unit
$I_{q1}$	Quiescent Current	$R_L = \infty$	120	200	320	mA
$V_{OS}$	Output Offset Voltage	Play Mode			$\pm 80$	mV
$dV_{OS}$	During mute ON/OFF output offset voltage				$\pm 80$	mV
$G_v$	Voltage Gain		25	26	27	dB
$dG_v$	Channel Gain Unbalance				$\pm 1$	dB
$P_o$	Output Power	$V_S = 13.2V$ ; THD = 10%	23	25		W
		$V_S = 13.2V$ ; THD = 1%	16	19		W
		$V_S = 14.4V$ ; THD = 10%	28	30		W
		$V_S = 14.4V$ ; THD = 1%	20	23		W
		$V_S = 13.2V$ ; THD = 10%, $2\Omega$	42	45		W
		$V_S = 13.2V$ ; THD = 1%, $2\Omega$	32	34		W
		$V_S = 14.4V$ ; THD = 10%, $2\Omega$	50	55		W
		$V_S = 14.4V$ ; THD = 1%, $2\Omega$	40	43		W
$P_o$ EIAJ	EIAJ Output Power (*)	$V_S = 13.7V$ ; $R_L = 4\Omega$	41	45		W
		$V_S = 13.7V$ ; $R_L = 2\Omega$	75	77		W
$P_o$ max.	Max. Output Power (*)	$V_S = 14.4V$ ; $R_L = 4\Omega$		50		W
		$V_S = 14.4V$ ; $R_L = 2\Omega$		80		W
THD	Distortion	$P_o = 4W$		0.006	0.05	%
		$P_o = 10W$ ; $R_L = 2\Omega$		0.015	0.07	%
$e_{No}$	Output Noise	"A" Weighted Bw = 20Hz to 20KHz		35	50	$\mu V$
					50	70
SVR	Supply Voltage Rejection	$f = 100Hz$ ; $V_r = 1V_{rms}$	50	70		dB
$f_{ch}$	High Cut-Off Frequency	$P_o = 0.5W$	100	300		KHz
$R_i$	Input Impedance		80	100	120	K $\Omega$
$C_T$	Cross Talk	$f = 1KHz$ $P_o = 4W$	60	70	-	dB
		$f = 10KHz$ $P_o = 4W$		60	-	dB
$I_{SB}$	St-By Current Consumption	$V_{St-By} = 1.5V$			75	$\mu A$
$I_{pin4}$	St-by pin Current	$V_{St-By} = 1.5V$ to $3.5V$			$\pm 10$	$\mu A$
$V_{SB out}$	St-By Out Threshold Voltage	(Amp: ON)	3.5			V
$V_{SB in}$	St-By in Threshold Voltage	(Amp: OFF)			1.5	V
$A_M$	Mute Attenuation	$P_{Oref} = 4W$	80	90		dB
$V_{M out}$	Mute Out Threshold Voltage	(Amp: Play)	3.5			V
$V_{M in}$	Mute In Threshold Voltage	(Amp: Mute)			1.5	V
$V_{AM in}$	$V_S$ Automute Threshold	(Amp: Mute) Att $\geq 80dB$ ; $P_{Oref} = 4W$	6.5	7		V
		(Amp: Play) Att $< 0.1dB$ ; $P_o = 0.5W$		7.5	8	V
$I_{pin22}$	Muting Pin Current	$V_{MUTE} = 1.5V$ (Sourced Current)	7	12	18	$\mu A$
		$V_{MUTE} = 3.5V$	-5		18	$\mu A$
<b>HSD SECTION</b>						
$V_{dropout}$	Dropout Voltage	$I_o = 0.35A$ ; $V_S = 9$ to $16V$		0.25	0.6	V
$I_{prot}$	Current Limits		400		800	mA

(\*) Saturated square wave output.

Figure 1: Standard Test and Application Circuit

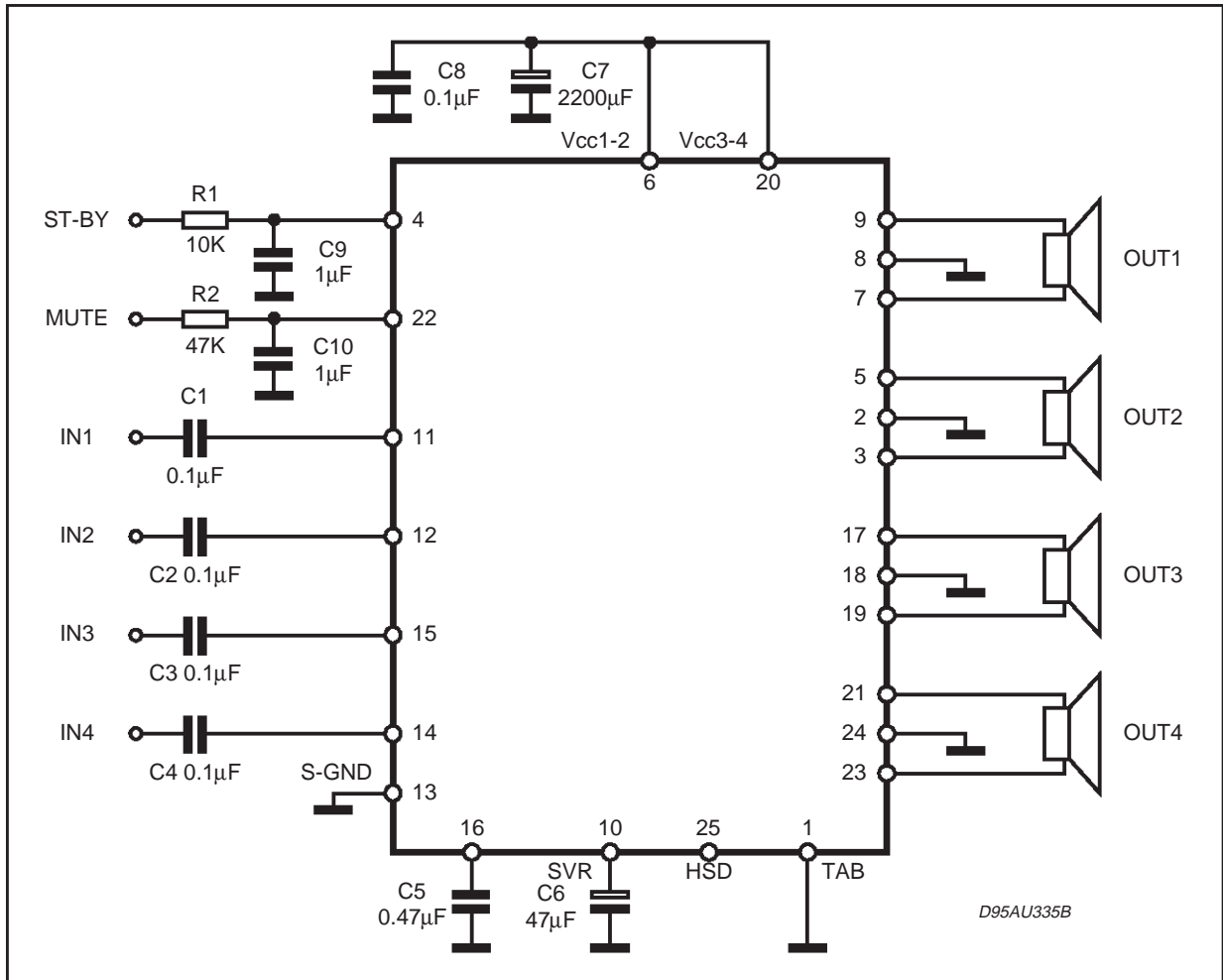

Figure 2: P.C.B. and component layout of the figure 1 (1:1 scale)

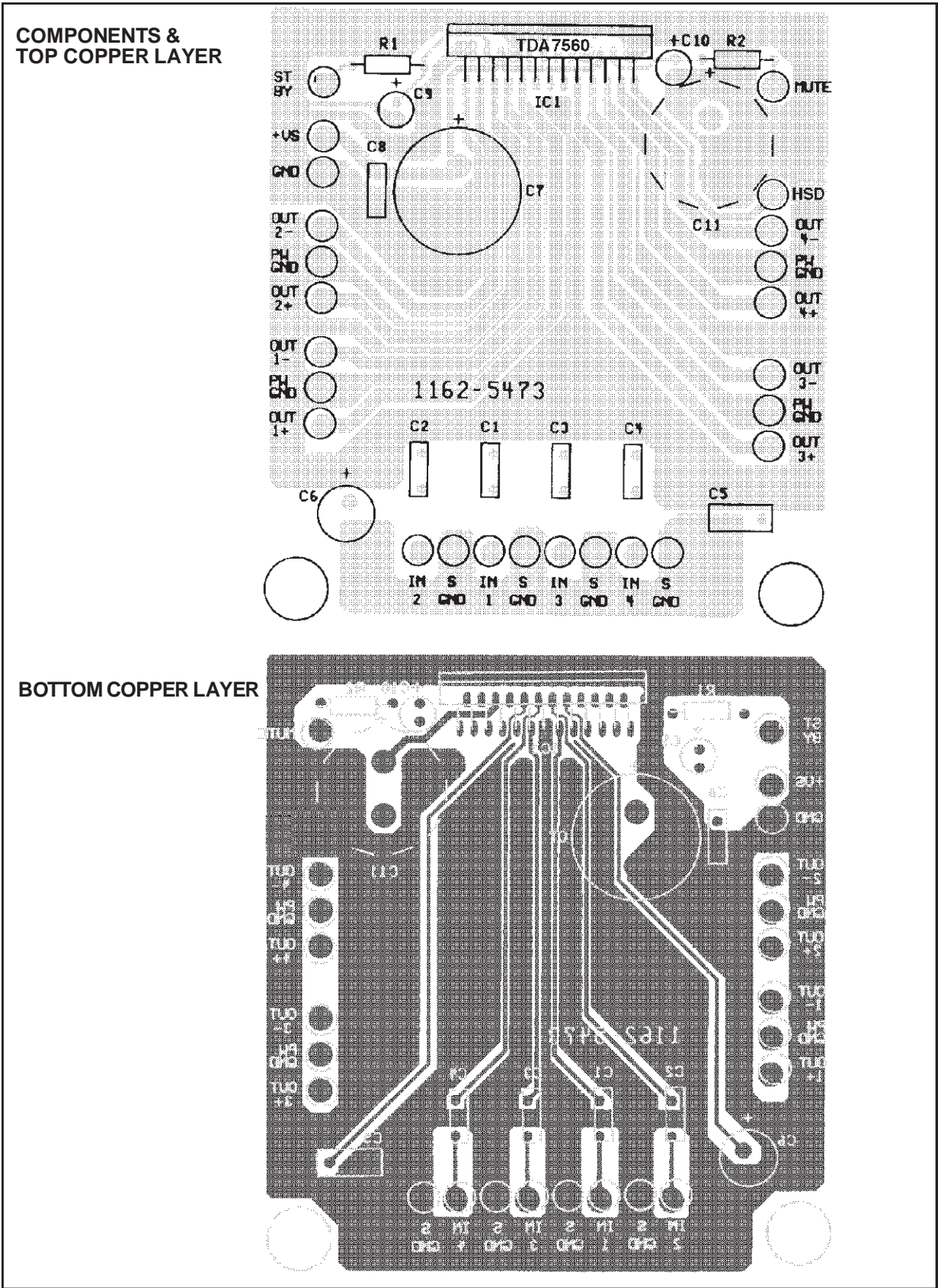

Figure 3. Quiescent current vs. supply voltage.

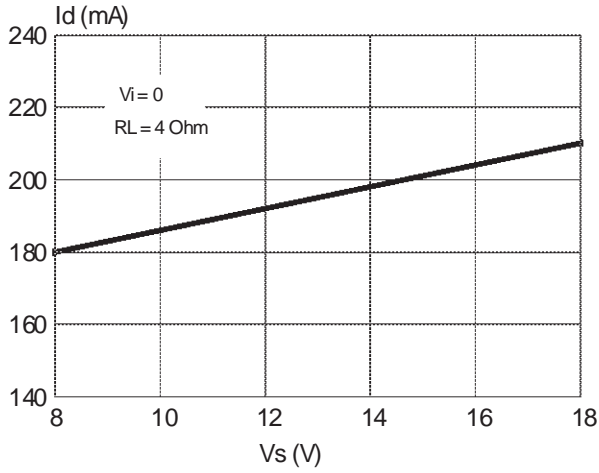

Figure 4. Output power vs. supply voltage.

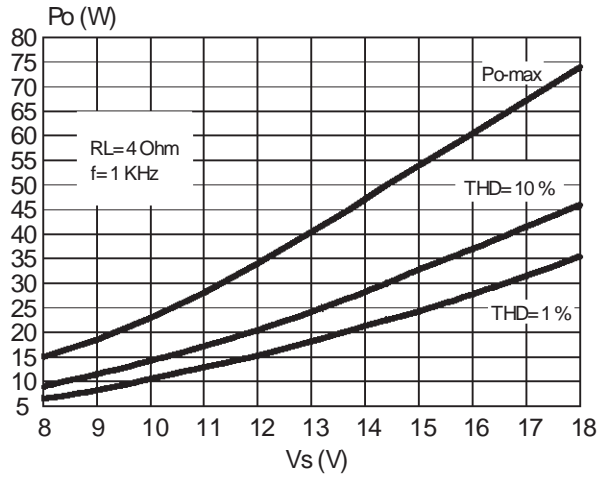

Figure 5. Output power vs. supply voltage.

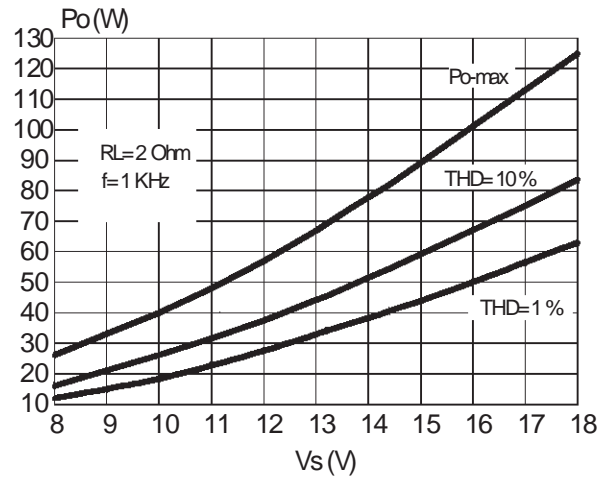

Figure 6. Distortion vs. output Power

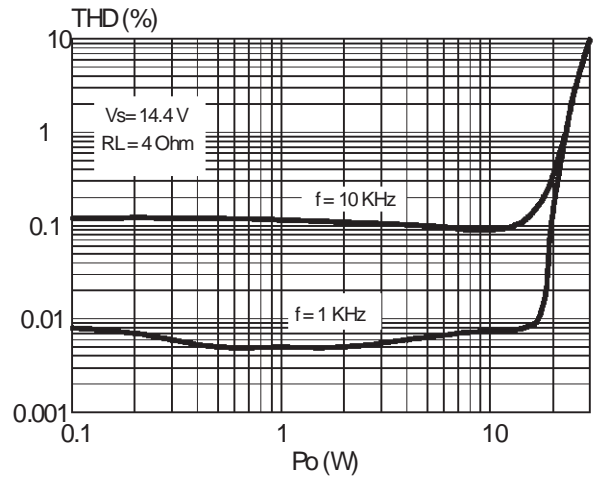

Figure 7. Distortion vs. output power

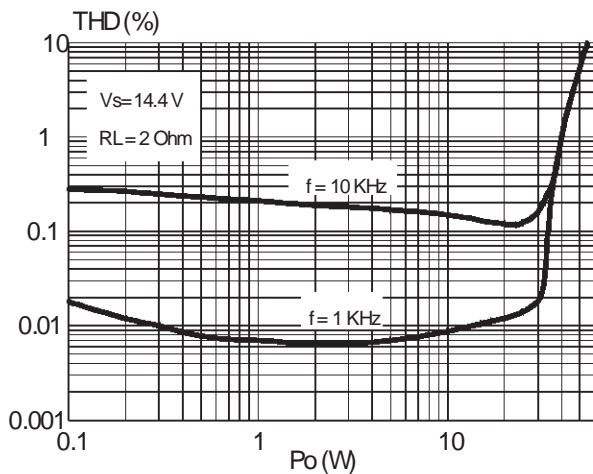

Figure 8. Distortion vs. frequency.

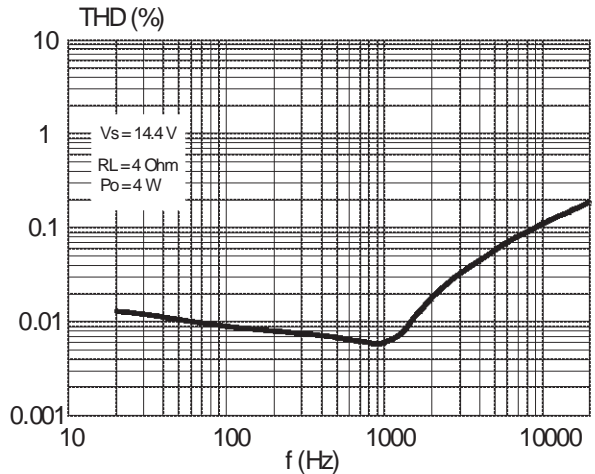

Figure 9. Distortion vs. frequency.

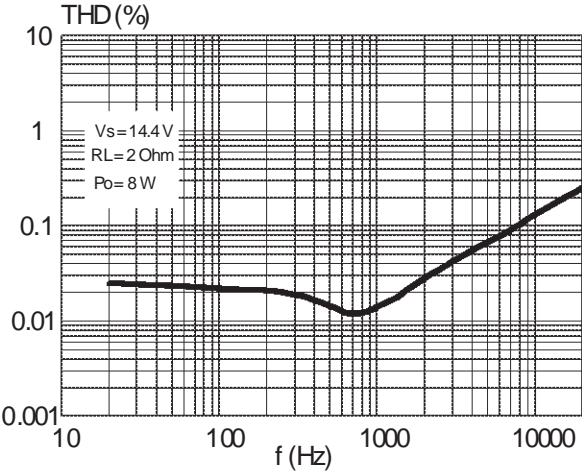

Figure 10. Crosstalk vs. frequency.

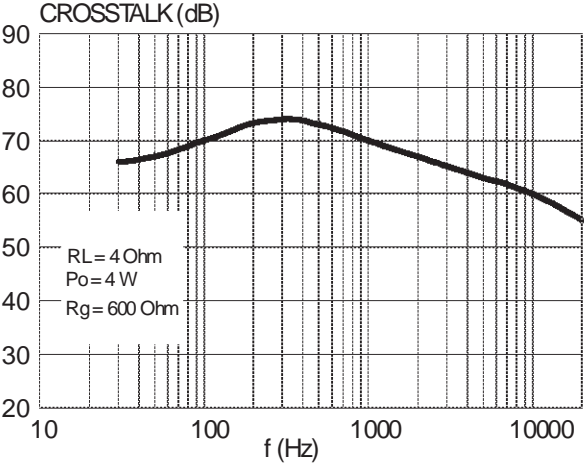

Figure 11. Supply voltage rejection vs. frequency.

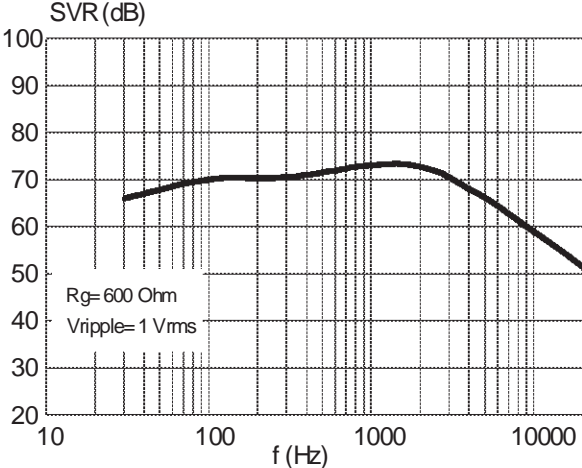

Figure 12. Output attenuation vs. supply voltage.

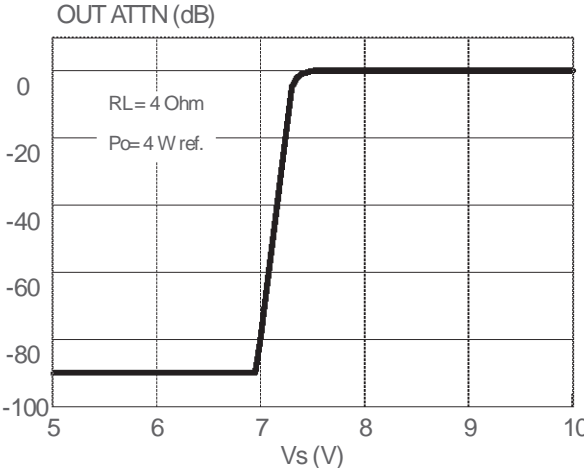

Figure 13. Output noise vs. source resistance.

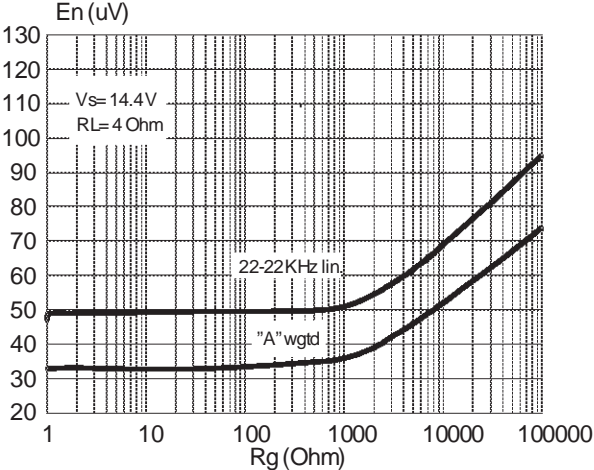

Figure 14. Power dissipation & efficiency vs. output power (sine-wave operation)

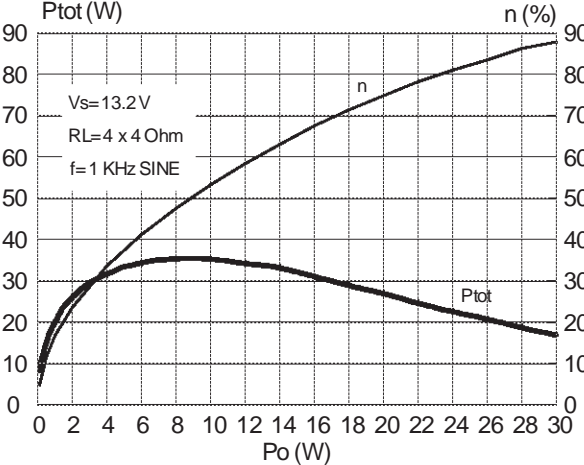

Figure 15. Power dissipation vs. output power (Music/Speech Simulation)

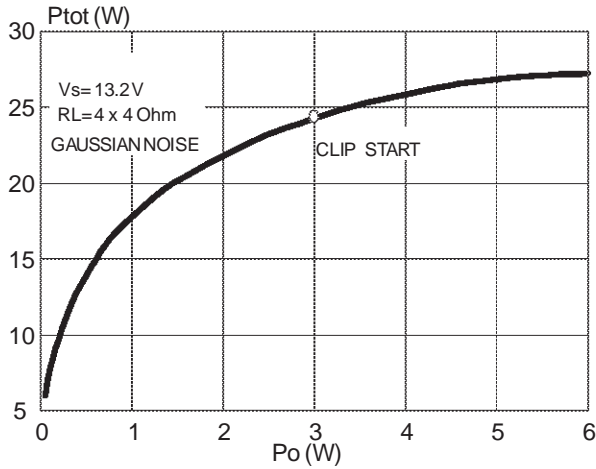
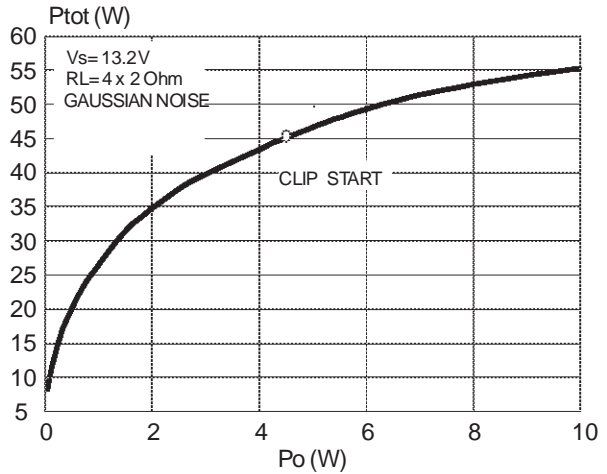

Figure 16. Power dissipation vs. output power (Music/Speech Simulation)



**APPLICATION HINTS** (ref. to the circuit of fig. 1)

SVR

Besides its contribution to the ripple rejection, the SVR capacitor governs the turn ON/OFF time sequence and, consequently, plays an essential role in the pop optimization during ON/OFF transients. To conveniently serve both needs, **ITS MINIMUM RECOMMENDED VALUE IS 10µF.**

INPUT STAGE

The TDA7560's inputs are ground-compatible and can stand very high input signals ( $\pm 8V_{pk}$ ) without any performances degradation.

If the standard value for the input capacitors (0.1µF) is adopted, the low frequency cut-off will amount to 16 Hz.

STAND-BY AND MUTING

STAND-BY and MUTING facilities are both CMOS-COMPATIBLE. If unused, a straight connection to Vs of their respective pins would be admissible. Conventional low-power transistors can

be employed to drive muting and stand-by pins in absence of true CMOS ports or microprocessors.

R-C cells have always to be used in order to smooth down the transitions for preventing any audible transient noises.

About the stand-by, the time constant to be assigned in order to obtain a virtually pop-free transition has to be slower than 2.5V/ms.

HEATSINK DEFINITION

Under normal usage (4 Ohm speakers) the heatsink's thermal requirements have to be deduced from fig. 15, which reports the simulated power dissipation when real music/speech programmes are played out. Noise with gaussian-distributed amplitude was employed for this simulation. Based on that, frequent clipping occurrence (worst-case) will cause  $P_{diss} = 26W$ . Assuming  $T_{amb} = 70^{\circ}C$  and  $T_{CHIP} = 150^{\circ}C$  as boundary conditions, the heatsink's thermal resistance should be approximately  $2^{\circ}C/W$ . This would avoid any thermal shutdown occurrence even after long-term and full-volume operation.



DIM.	mm			inch		
	MIN.	TYP.	MAX.	MIN.	TYP.	MAX.
A	4.45	4.50	4.65	0.175	0.177	0.183
B	1.80	1.90	2.00	0.070	0.074	0.079
C		1.40			0.055	
D	0.75	0.90	1.05	0.029	0.035	0.041
E	0.37	0.39	0.42	0.014	0.015	0.016
F (1)			0.57			0.022
G	0.80	1.00	1.20	0.031	0.040	0.047
G1	23.75	24.00	24.25	0.935	0.945	0.955
H (2)	28.90	29.23	29.30	1.138	1.150	1.153
H1		17.00			0.669	
H2		12.80			0.503	
H3		0.80			0.031	
L (2)	22.07	22.47	22.87	0.869	0.884	0.904
L1	18.57	18.97	19.37	0.731	0.747	0.762
L2 (2)	15.50	15.70	15.90	0.610	0.618	0.626
L3	7.70	7.85	7.95	0.303	0.309	0.313
L4		5			0.197	
L5		3.5			0.138	
M	3.70	4.00	4.30	0.145	0.157	0.169
M1	3.60	4.00	4.40	0.142	0.157	0.173
N		2.20			0.086	
O		2			0.079	
R		1.70			0.067	
R1		0.5			0.02	
R2		0.3			0.12	
R3		1.25			0.049	
R4		0.50			0.019	
V					5° (Typ.)	
V1					3° (Typ.)	
V2					20° (Typ.)	
V3					45° (Typ.)	

**OUTLINE AND MECHANICAL DATA**

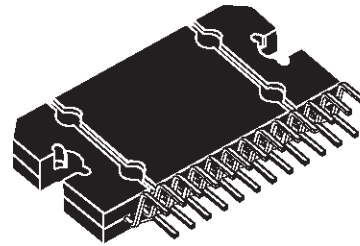

**Flexiwatt25**

(1): dam-bar protusion not included  
 (2): molding protusion included

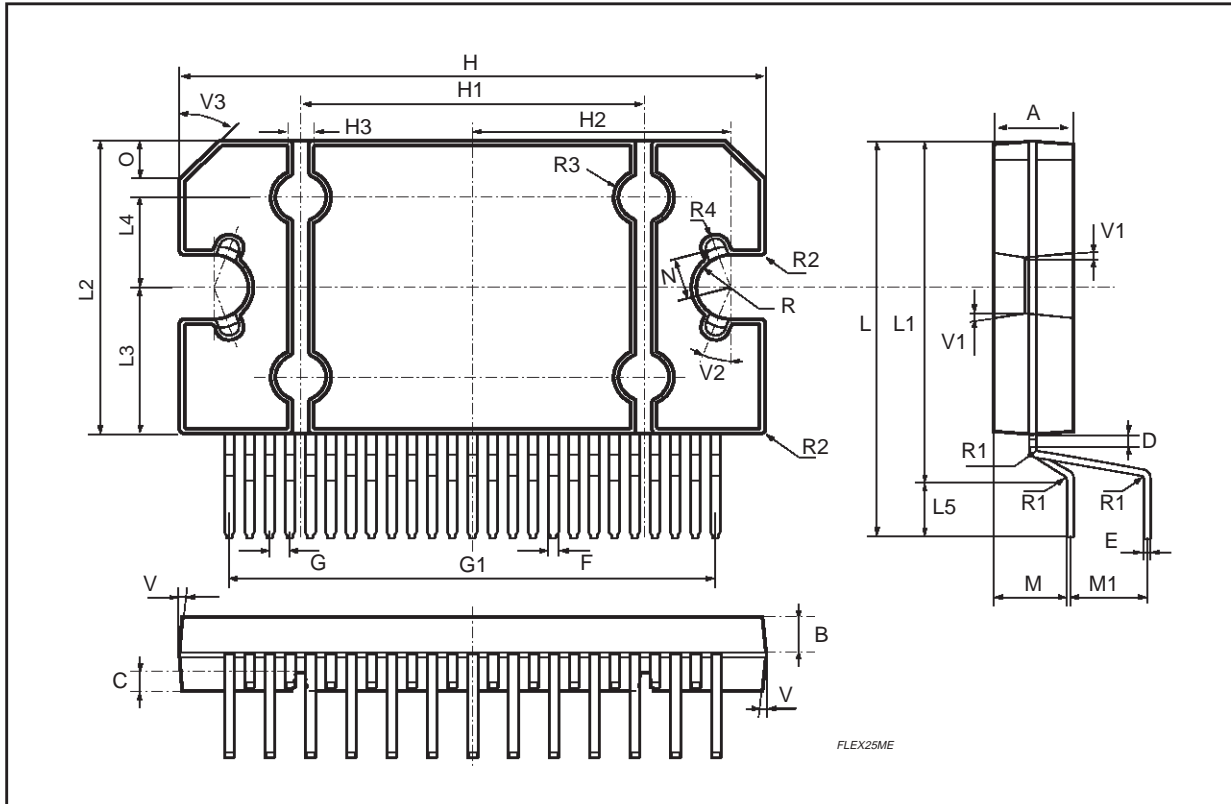

Information furnished is believed to be accurate and reliable. However, STMicroelectronics assumes no responsibility for the consequences of use of such information nor for any infringement of patents or other rights of third parties which may result from its use. No license is granted by implication or otherwise under any patent or patent rights of STMicroelectronics. Specification mentioned in this publication are subject to change without notice. This publication supersedes and replaces all information previously supplied. STMicroelectronics products are not authorized for use as critical components in life support devices or systems without express written approval of STMicroelectronics.

The ST logo is a registered trademark of STMicroelectronics

© 1999 STMicroelectronics – Printed in Italy – All Rights Reserved

STMicroelectronics GROUP OF COMPANIES

Australia - Brazil - China - Finland - France - Germany - Hong Kong - India - Italy - Japan - Malaysia - Malta - Morocco -  
Singapore - Spain - Sweden - Switzerland - United Kingdom - U.S.A.

<http://www.st.com>